

Fast Charge Deep Cycle Lead-Carbon Battery HDC12-110

HDC series lead-carbon batteries use functional activated carbon and graphene as carbon materials, which are added to the negative plate of the battery to make lead carbon batteries have the advantages of both lead-acid batteries and super capacitors. It not only improves the ability of rapid charge and discharge, but also greatly prolongs the battery life. It is more suitable for the application of PSOC.

12V
110Ah

Lead Carbon
Technology

Deep
Cycle



COMPLIED STANDARDS

IEC 60869-21-22 JIS C8704 YD/T799
BS6290 part4 GB/T 19638 UL 1989



General Features

- ✓ Combine the characteristics of lead acid battery and super capacitor
- ✓ Long life cycle service design, excellent PSOC and cyclic performance
- ✓ High power, rapid charging and discharging
- ✓ Unique grid and lead pasting design
- ✓ Extreme temperature tolerance
- ✓ Able to operate at -30°C ~60°C
- ✓ Deep Discharge recovery capability

Applications

- Home Energy storage system
- Smart Power grid system
- Solar & Wind Power system
- Wheel chair, Golf Car
- Telecom systems
- BTS Stations
- Micro-grid system

Technical Specifications

Dimensions & Weight

Length(mm)	407±1
Width(mm)	174±1
Height(mm)	208±1
Total Height(mm)	233±1
Weight(kg)	39.0±3%

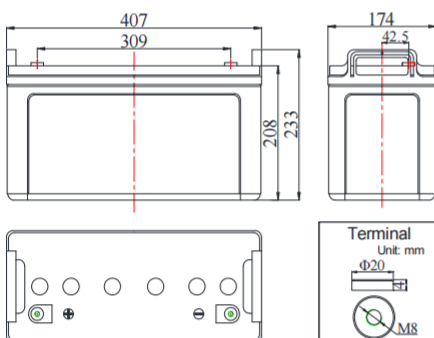

Battery Discharge Table

Discharge Constant Current per Cell(Ampers at 25 °C)

F.V/Time	5min	10min	15min	20min	25min	30min	35min	40min	45min	60min	90min	2h	3h	4h	5h	6h	7h	8h	10h	12h	20h
1.60V	299.1	190.7	162.0	132.0	116.3	103.6	91.5	83.1	76.0	66.2	53.4	42.0	29.5	24.2	20.0	16.8	14.8	13.2	11.21	9.42	5.83
1.65V	293.7	187.2	159.1	129.8	114.3	101.7	89.7	81.6	74.7	64.9	52.4	41.2	28.9	23.7	19.6	16.4	14.5	13.0	11.00	9.26	5.72
1.67V	290.8	185.4	157.4	127.7	113.3	100.8	89.2	81.2	74.3	64.3	52.0	40.8	28.7	23.4	19.4	16.3	14.4	12.9	10.88	9.19	5.67
1.70V	284.9	182.0	154.3	125.4	111.2	98.8	87.8	79.8	73.0	63.0	50.9	40.5	28.4	23.2	19.3	16.2	14.3	12.7	10.66	9.03	5.62
1.75V	282.7	180.1	153.2	123.9	109.5	97.9	86.6	78.7	72.0	62.2	50.5	39.6	27.9	22.9	18.9	15.9	14.0	12.5	10.55	8.89	5.50
1.80V	273.8	174.4	147.9	121.1	106.2	94.8	84.1	76.4	69.9	60.3	48.9	38.1	26.8	21.8	18.2	15.4	13.4	12.0	10.21	8.59	5.34

Discharge Constant Power per Cell(Watts at 25 °C)

F.V/Time	5min	10min	15min	20min	25min	30min	35min	40min	45min	60min	90min	2h	3h	4h	5h	6h	7h	8h	10h	12h	20h
1.60V	560.5	359.5	305.5	250.0	221.3	197.9	174.7	159.3	145.8	127.0	102.4	80.6	56.7	46.3	38.3	32.1	28.3	25.4	21.4	18.2	11.33
1.65V	552.4	354.1	301.8	247.0	218.3	195.1	171.6	156.1	143.6	124.7	100.6	79.3	55.7	45.6	37.8	31.5	28.0	25.0	21.1	17.8	11.22
1.67V	548.5	351.2	299.0	244.5	216.5	193.4	170.7	155.6	142.8	123.4	99.9	78.6	55.2	45.1	37.4	31.4	27.7	24.8	21.0	17.7	11.17
1.70V	543.5	346.2	294.2	239.9	212.6	189.6	168.3	153.1	140.6	121.2	97.8	77.8	54.6	44.6	37.1	31.2	27.5	24.5	20.5	17.4	11.11
1.75V	540.6	343.3	292.3	236.8	209.6	187.8	166.2	151.3	138.4	119.9	96.9	76.3	53.6	43.9	36.4	30.7	27.0	24.0	20.3	17.2	10.89
1.80V	524.7	333.7	283.5	232.5	204.1	182.0	161.4	147.2	134.3	116.2	93.9	73.4	51.5	41.9	35.1	29.5	25.8	23.1	19.6	16.6	10.56

Note: The above data are average values, and can be obtained within 3 charge/discharge cycles. These are not minimum values. Cell and battery designs/specifications are subject to modification without notice. Contact **CSBattery** for the latest information.

Fast Charge Deep Cycle Lead-Carbon Battery HDC12-110

Performance Characteristics

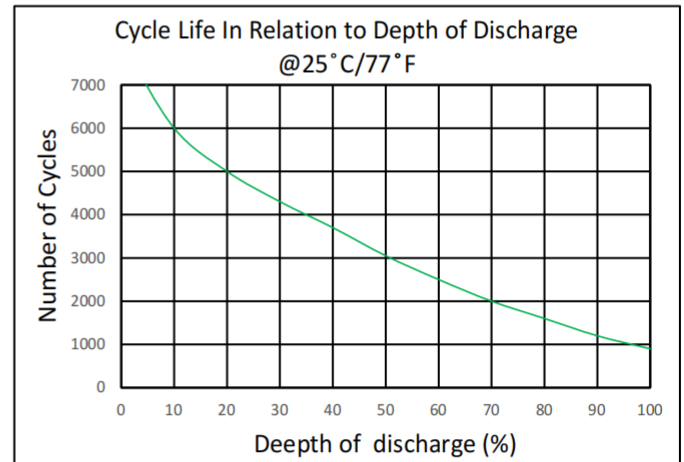
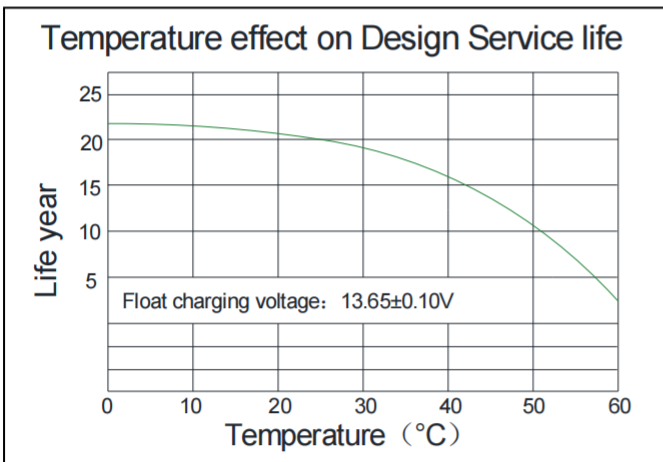
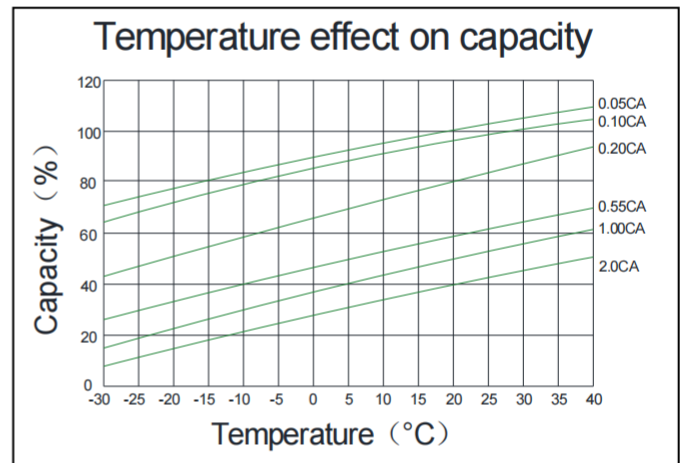
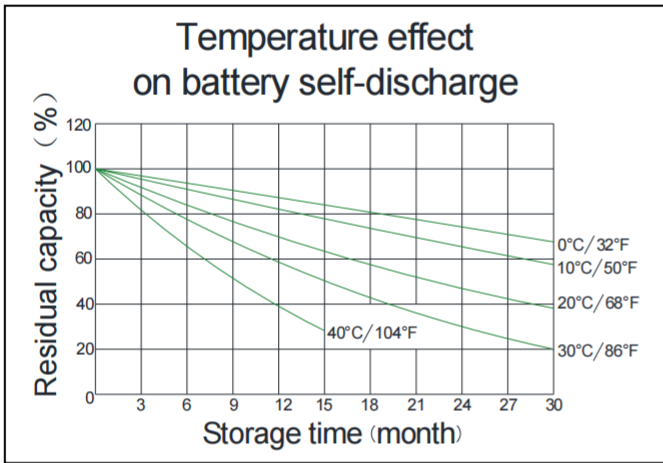
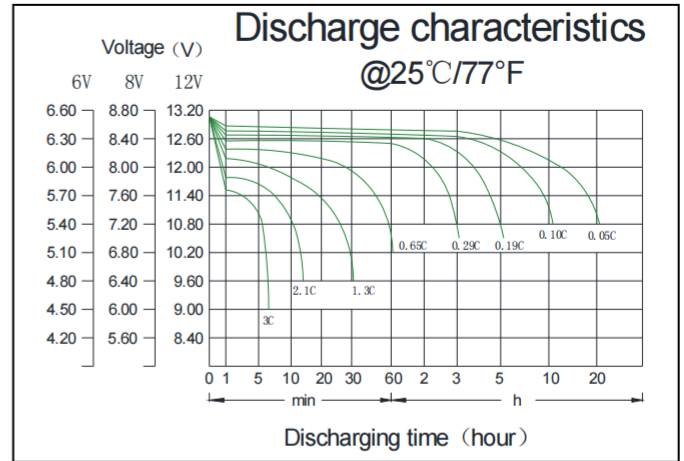
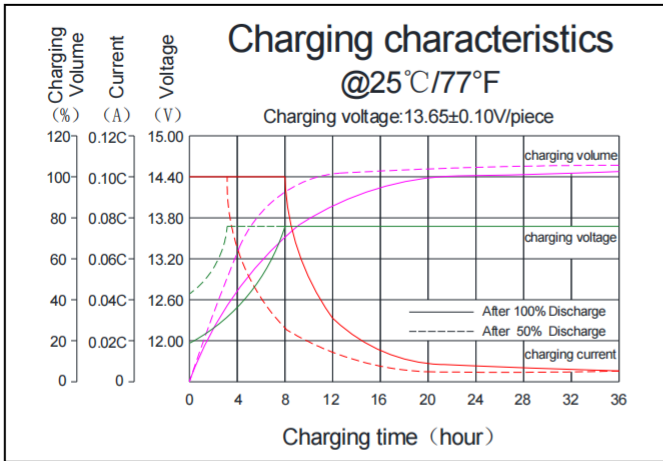

Battery Discharge Capacity

Long time discharge capacity for Offer Grid solar/wind application						
Capacity	C20(Ah)	C48(Ah)	C72(Ah)	C100(Ah)	C120(Ah)	C240(Ah)
Model	F.V=1.75VPC					
HDC12-110	110.00	112.93	115.87	222.00	121.99	125.18