

Fast Charge Deep Cycle Lead-Carbon Battery HDC12-120

HDC series lead-carbon batteries use functional activated carbon and graphene as carbon materials, which are added to the negative plate of the battery to make lead carbon batteries have the advantages of both lead-acid batteries and super capacitors. It not only improves the ability of rapid charge and discharge, but also greatly prolongs the battery life. It is more suitable for the application of PSOC.

**12V
120Ah**

**Lead Carbon
Technology**

**Deep
Cycle**



COMPLIED STANDARDS

IEC 60869-21-22 JIS C8704 YD/T799
BS6290 part4 GB/T 19638 UL 1989



General Features

- ✓ Combine the characteristics of lead acid battery and super capacitor
- ✓ Long life cycle service design, excellent PSOC and cyclic performance
- ✓ High power, rapid charging and discharging
- ✓ Unique grid and lead pasting design
- ✓ Extreme temperature tolerance
- ✓ Able to operate at -30°C ~60°C
- ✓ Deep Discharge recovery capability

Applications

- Home Energy storage system
- Smart Power grid system
- Solar & Wind Power system
- Wheel chair, Golf Car
- Telecom systems
- BTS Stations
- Micro-grid system

Technical Specifications

Nominal Voltage		12V(6 cells per unit)
Design Floating Life @25°C		20 Years
Nominal Capacity @25°C(20 hour rate@6.00A,10.50V)		120.0Ah
Capacity @25°C	10 hour rate (11.14A,10.8V)	111.4Ah
	5 hour rate (20.6A,10.5V)	103.0Ah
	1 hour rate (72.2A,9.60V)	72.2Ah
Internal Resistance	Full Charged Battery@25°C	≤5.0mΩ
Ambient Temperature	Discharge	-30°C~60°C
	Charge	-30°C~60°C
	Storage	-30°C~60°C
Max. Discharge Current@25°C		1200A(5s)
Capacity affected by Temperature (10 hr Capacity)	40°C	108%
	25°C	100%
	0°C	90%
	-15°C	70%
Self-Discharge@25°C per Month		3%
Charge (Constant Voltage) @25°C	Standby Use	Initial Charging Current Less than 30.0A Voltage 13.6-13.8V
	Cycle Use	Initial Charging Current Less than 30.0A Voltage 14.4-14.7V

Dimensions & Weight

Length(mm)	341±1
Width(mm)	173±1
Height(mm)	283±1
Total Height(mm)	287±1
Weight(kg)	40.5±3%

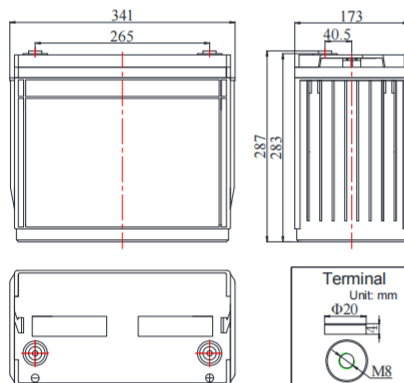

Battery Discharge Table

Discharge Constant Current per Cell(Ampers at 25 °C)

F.V/Time	5min	10min	15min	20min	25min	30min	35min	40min	45min	60min	90min	2h	3h	4h	5h	6h	7h	8h	10h	12h	20h
1.60V	326.3	208.1	176.7	143.9	126.9	113.0	99.8	90.7	82.9	72.2	58.3	45.8	32.2	26.4	21.8	18.3	16.1	14.4	12.23	10.28	6.36
1.65V	320.4	204.2	173.6	141.6	124.7	111.0	97.9	89.0	81.4	70.8	57.1	44.9	31.6	25.8	21.4	17.9	15.8	14.2	12.00	10.10	6.24
1.67V	317.2	202.3	171.7	139.3	123.6	110.0	97.4	88.6	81.0	70.1	56.7	44.5	31.3	25.6	21.2	17.8	15.7	14.0	11.87	10.02	6.18
1.70V	310.8	198.6	168.4	136.8	121.3	107.8	95.7	87.0	79.7	68.7	55.6	44.1	31.0	25.3	21.0	17.7	15.6	13.9	11.63	9.85	6.13
1.75V	308.4	196.5	167.1	135.1	119.4	106.8	94.5	85.9	78.6	67.9	55.1	43.2	30.4	24.9	20.6	17.4	15.3	13.6	11.51	9.69	6.00
1.80V	298.7	190.2	161.4	132.1	115.9	103.4	91.7	83.4	76.2	65.8	53.4	41.5	29.2	23.8	19.9	16.7	14.7	13.1	11.14	9.38	5.82

Discharge Constant Power per Cell(Watts at 25 °C)

F.V/Time	5min	10min	15min	20min	25min	30min	35min	40min	45min	60min	90min	2h	3h	4h	5h	6h	7h	8h	10h	12h	20h
1.60V	611.4	392.2	333.3	272.7	241.4	215.9	190.6	173.8	159.0	138.5	111.7	88.0	61.8	50.5	41.8	35.1	30.9	27.7	23.4	19.8	12.36
1.65V	602.6	386.3	329.2	269.4	238.1	212.9	187.2	170.3	156.7	136.1	109.7	86.5	60.8	49.7	41.3	34.4	30.5	27.3	23.0	19.5	12.24
1.67V	598.4	383.2	326.2	266.7	236.2	210.9	186.2	169.7	155.7	134.6	108.9	85.7	60.2	49.2	40.8	34.3	30.3	27.0	22.9	19.3	12.18
1.70V	592.9	377.7	320.9	261.8	232.0	206.8	183.6	167.0	153.4	132.2	106.7	84.9	59.6	48.7	40.5	34.0	30.0	26.7	22.4	19.0	12.12
1.75V	589.7	374.5	318.9	258.3	228.7	204.9	181.3	165.1	150.9	130.8	105.7	83.2	58.4	47.9	39.7	33.5	29.5	26.2	22.2	18.7	11.88
1.80V	572.4	364.1	309.3	253.7	222.6	198.6	176.1	160.5	146.5	126.7	102.4	80.1	56.2	45.7	38.3	32.2	28.2	25.2	21.4	18.1	11.52

Note: The above data are average values, and can be obtained within 3 charge/discharge cycles. These are not minimum values. Cell and battery designs/specifications are subject to modification without notice. Contact **CSBattery** for the latest information.

Fast Charge Deep Cycle Lead-Carbon Battery HDC12-120

Performance Characteristics

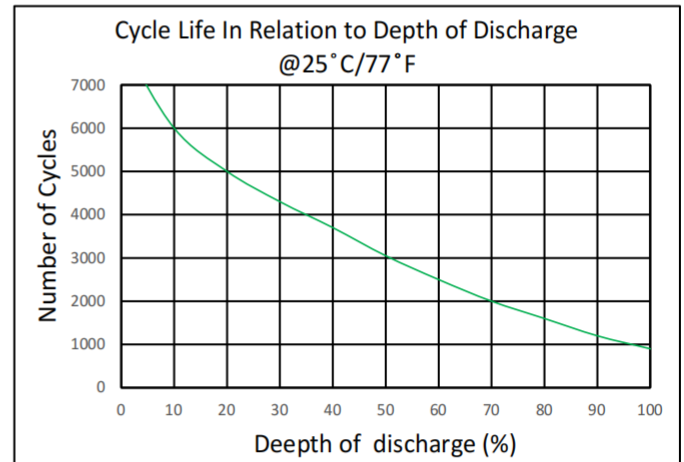
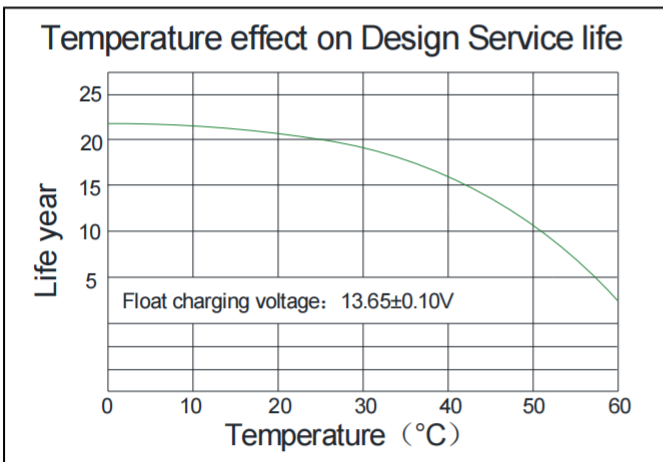
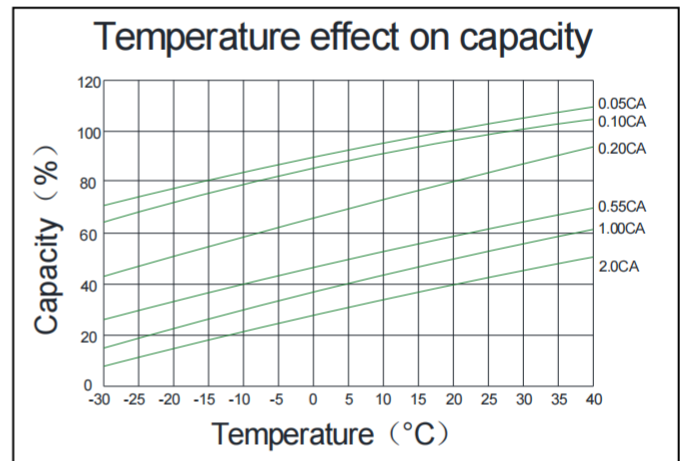
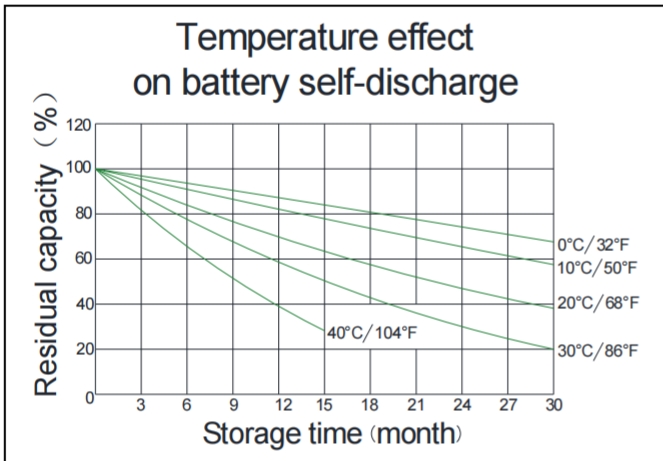
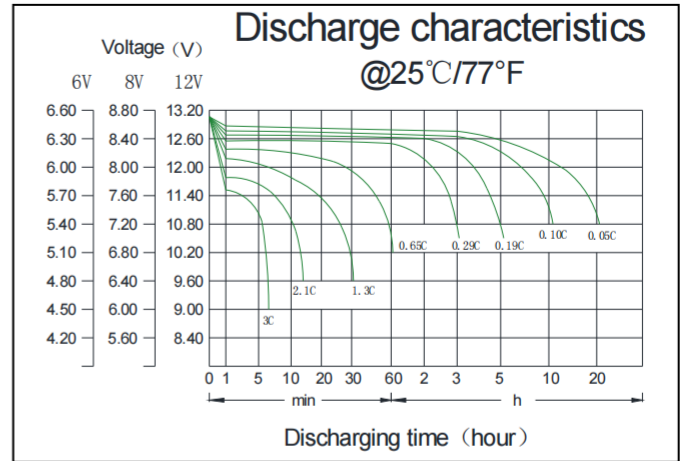
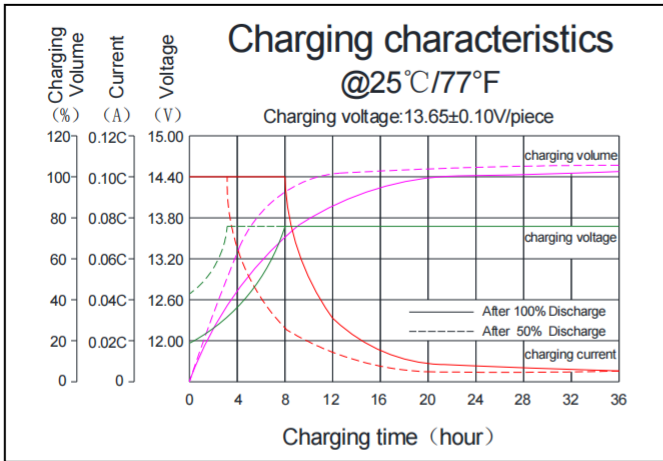

Battery Discharge Capacity

Long time discharge capacity for Offer Grid solar/wind application						
Capacity	C20(Ah)	C48(Ah)	C72(Ah)	C100(Ah)	C120(Ah)	C240(Ah)
	F.V=1.75VPC					
HDC12-120	120.00	123.20	126.40	222.00	133.08	136.56