

## Sealed Lead Acid Durable AGM Battery

## GB12-120

CSBattery GB series AGM batteries are designed to have a large amount of stored current discharged between charging sessions, with very heavy non-porous battery plates to withstand repeated major discharging and charging cycle. The CSBattery VRLA AGM battery uses a different chemistry for the plates active paste material, and a slightly stronger electrolyte than normal battery electrolyte, thus the GB range features higher cyclic life with 10 years of float life when compared to the standard Duration range.

12V  
120Ah

AGM  
Technology

VRLA  
Battery



### Applications

- Telecom Control Equipments
- UPS systems, Inverter
- Power Equipments
- Solar&Wind
- Emergency Power Systems

### General Features

- ✓ 30% more cyclic life through innovation at the PAM additives
- ✓ Long life expectancy of 10 years in floating condition
- ✓ Thick flat plate with high Tin low Calcium alloy
- ✓ Excellent deep discharge recovery capability
- ✓ Deep cycle performance: up to 700 cycles@50%DOD

### Dimensions & Weight

Length(mm/inch)	407/16.03
Width(mm/inch)	174/6.85
Height(mm/inch)	210/8.27
Total Height(mm/inch)	233/9.18
Weight(kg/lbs)(±3%)	34/75

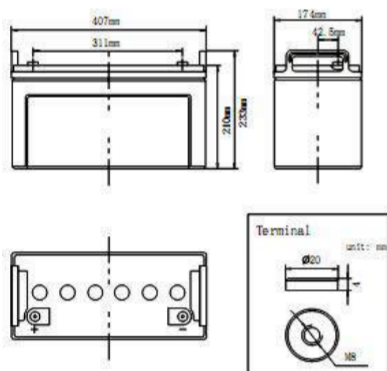

### Technical Specifications

Nominal Voltage		12V(6 cells per unit)
Design Floating Life @25°C		10 Years
Nominal Capacity @25°C(10 hour rate@12.0A,10.8V)		120Ah
Capacity @25°C	20hour rate (6.66A,10.8V)	133.2Ah
	5 hour rate (21.9A,10.5V)	109.5Ah
	1 hour rate (79.8A,9.6V)	79.8Ah
Internal Resistance	Full Charged Battery@25°C	≤5.0mΩ
Ambient Temperature	Discharge	-15°C~45°C
	Charge	-15°C~45°C
	Storage	-15°C~45°C
Max.Discharge Current@25°C		720A (5s)
Capacity affected by Temperature (10 hour)	40°C	105%
	25°C	100%
	0°C	85%
	-15°C	65%
Self-Discharge@25°C per Month		3%
Charge (Constant Voltage) @25°C	Standby Use	Initial Charging Current Less than 30A Voltage 13.6-13.8V
	Cycle Use	Initial Charging Current Less than 30A Voltage 14.4-14.9V

### COMPLIED STANDARDS



### Battery Discharge Table

#### Discharge Constant Current per Cell (Amperes at 25°C)

F.V/Time	15min	30min	45min	1h	2h	3h	5h	8h	10h	20h
1.60V	202.6	126.1	90.5	79.8	48.7	35.6	22.9	14.0	12.48	6.93
1.65V	194.2	122.7	88.0	77.7	47.8	34.9	22.6	13.8	12.36	6.86
1.70V	185.7	119.3	85.6	75.6	46.9	34.3	22.2	13.7	12.24	6.79
1.75V	177.3	115.9	83.2	73.4	45.8	33.5	21.9	13.6	12.12	6.73
1.80V	168.8	112.6	80.8	71.3	44.6	32.6	21.6	13.4	12.00	6.66

#### Discharge Constant Power per Cell (Watts at 25°C)

F.V/Time	15min	30min	45min	1h	2h	3h	5h	8h	10h	20h
1.60V	377.9	235.1	168.7	148.9	90.7	66.4	42.7	26.1	23.3	12.9
1.65V	362.1	228.8	164.2	144.9	89.1	65.1	42.1	25.8	23.1	12.8
1.70V	346.4	222.5	159.7	140.9	87.4	63.9	41.5	25.6	22.8	12.7
1.75V	330.6	216.2	155.1	136.9	85.3	62.4	40.9	25.3	22.6	12.5
1.80V	314.9	209.9	150.6	132.9	83.3	60.9	40.3	25.1	22.4	12.4

**Note:** The above data are average values, and can be obtained within 3 charge/discharge cycles. These are not minimum values. Cell and battery designs/specifications are subject to modification without notice. Contact **CSBattery** for the latest information.

### Performance Characteristics

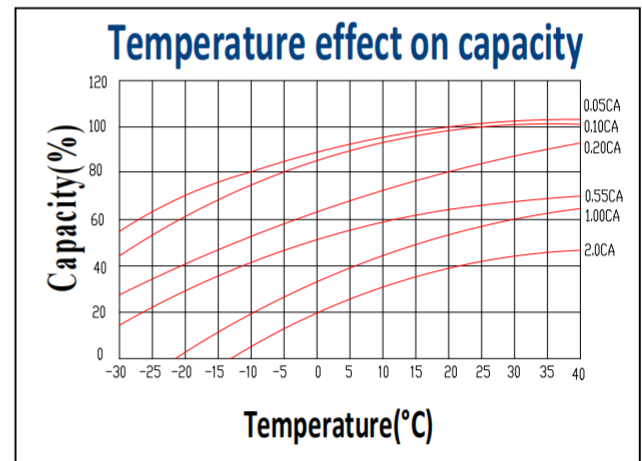
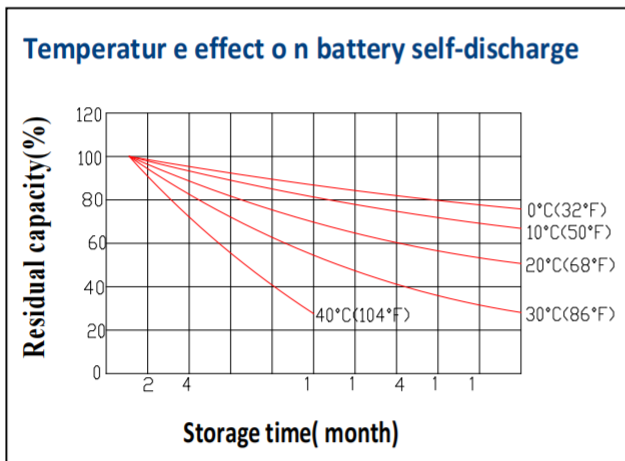
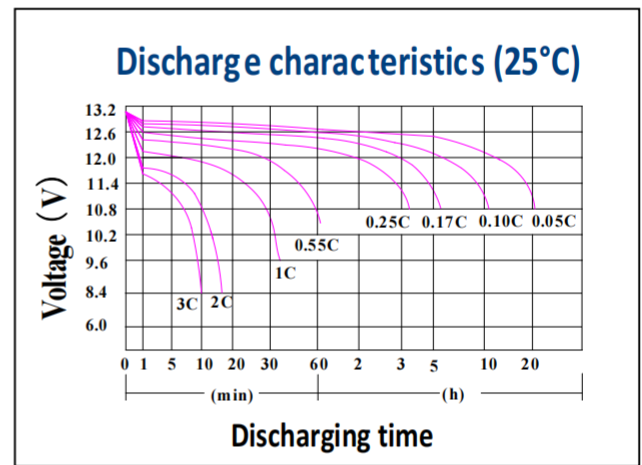
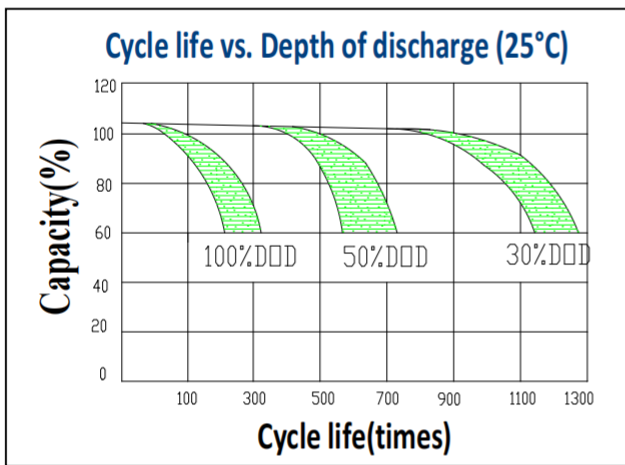
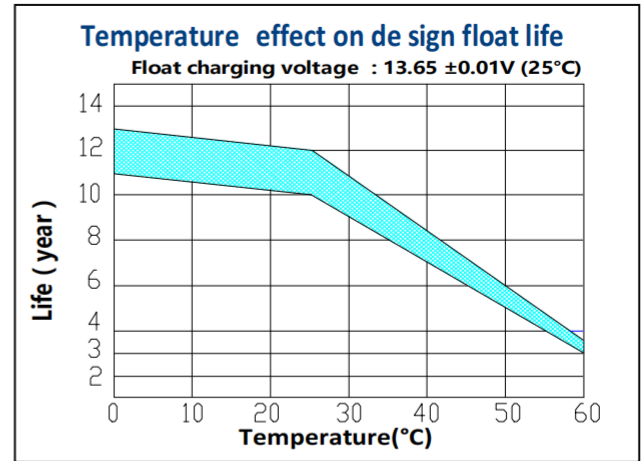
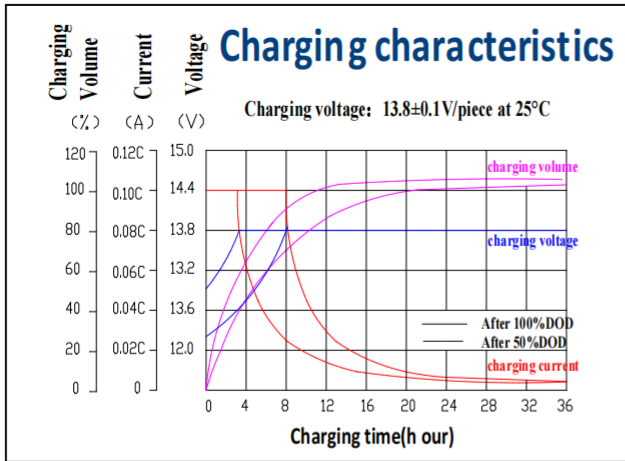

### Battery Construction

Component	Positive plate	Negative plate	Container & Cover	Safety valve	Terminal	Separator	Electrolyte	Pillar seal
Features	Thick high Sn low Ca grid with special paste	Balanced Pb-Ca grid for improved recombination efficiency	Fire resistance ABS (UL94-V0)	Flame Si-Rubber and aging resistance	Female Copper Insert M8	Advanced AGM separator for high pressure cell design	Dilute high purity sulfuric acid	Two layers epoxy resin seal

Add: Building Evolution, Xingdong industry Park, NO.61, Liuxian 2nd Road, Baoan, Shenzhen, China.

Tel: +86-755-29123661 Email: [Sales@CSBattery.cn](mailto:Sales@CSBattery.cn), [Support@CSBattery.cn](mailto:Support@CSBattery.cn)

Website: [www.CSBattery.cn](http://www.CSBattery.cn)